

SECTION VIEW - ANTIFLOTATION BASE

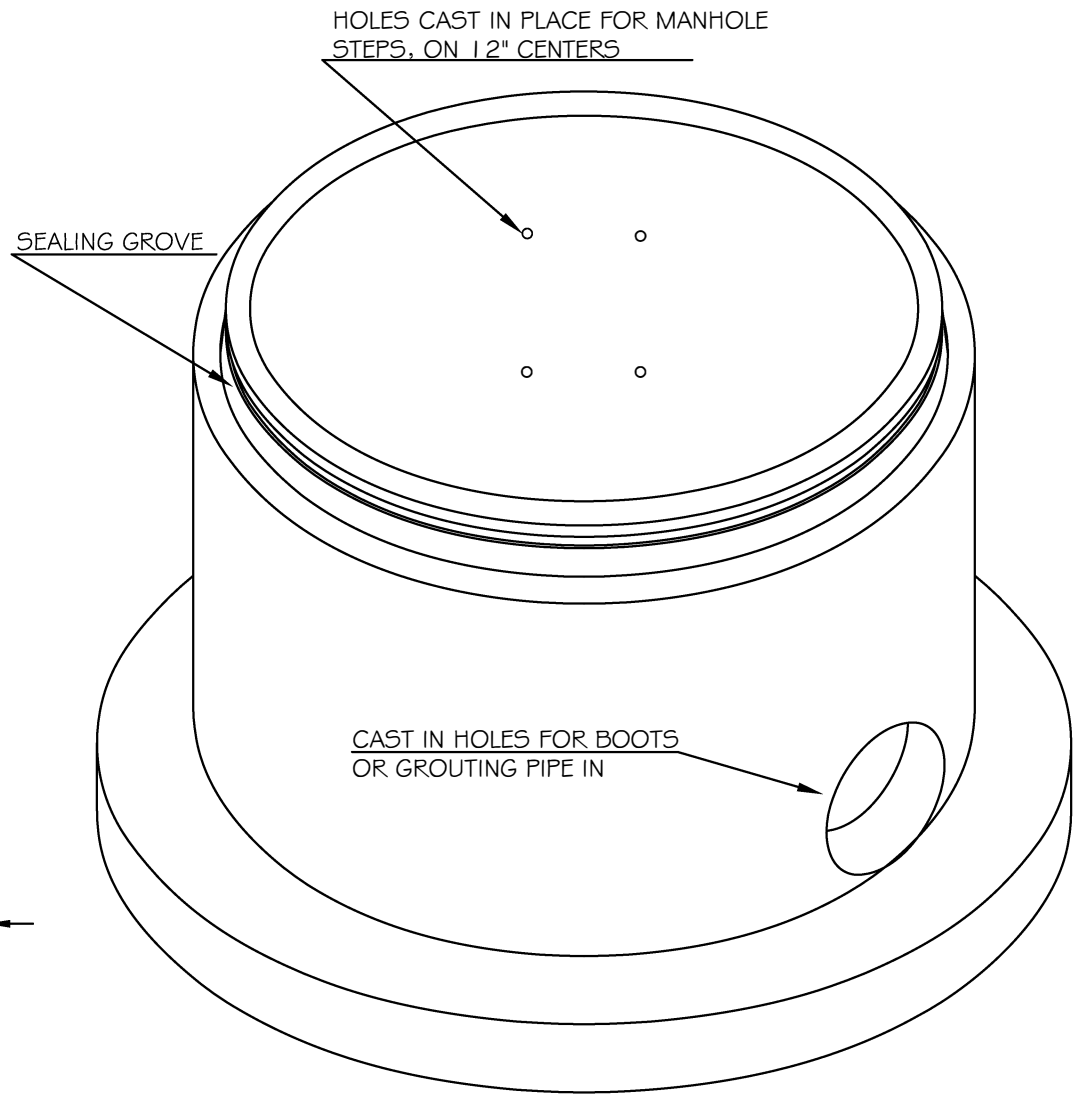

ISOMETRIC VIEW

NOTE:
MANHOLE BASES ARE MANUFACTURED
TO ASTM C-478-90B SPECIFICATIONS

PHONE: 800-837-8918



P.O. Box 265, WAVERLY, WV 26184-0265

MANHOLE ANTIFLOTATION BASE 48" DIA.

DWG.NO.	
1	
OF	
1	
REV	DATE

FILE# DRAWN BY KJK DATE 4/13/2012